



**WX370 Tractor Mount Splitter
Parts Manual
S/N 2370357 to S/N 2370476**



Foreword

EMB Mfg. has prepared this parts manual to assist customers in ordering quality OEM replacement parts.

Proper and regular service and replacing old, worn or broken parts with the correct Wallenstein parts are essential to prolonging the life of your Wallenstein product. Please refer to this manual before ordering any replacement parts.

All information contained in this parts manual is based on the latest product specification available at the time of printing this manual. If your product differs from the specifications contained within this manual contact EMB Mfg. for information.

EMB reserves the right to alter specifications on their products at any time.

Reproduction of this parts manual of any kind is prohibited without prior written permission from EMB Mfg.

Table of Contents

Cylinder	4
Main Parts	5
Valve Assembly	6
Valve and Fittings	8
4-Way Wedge (Optional)	9
Decal Breakdown	10

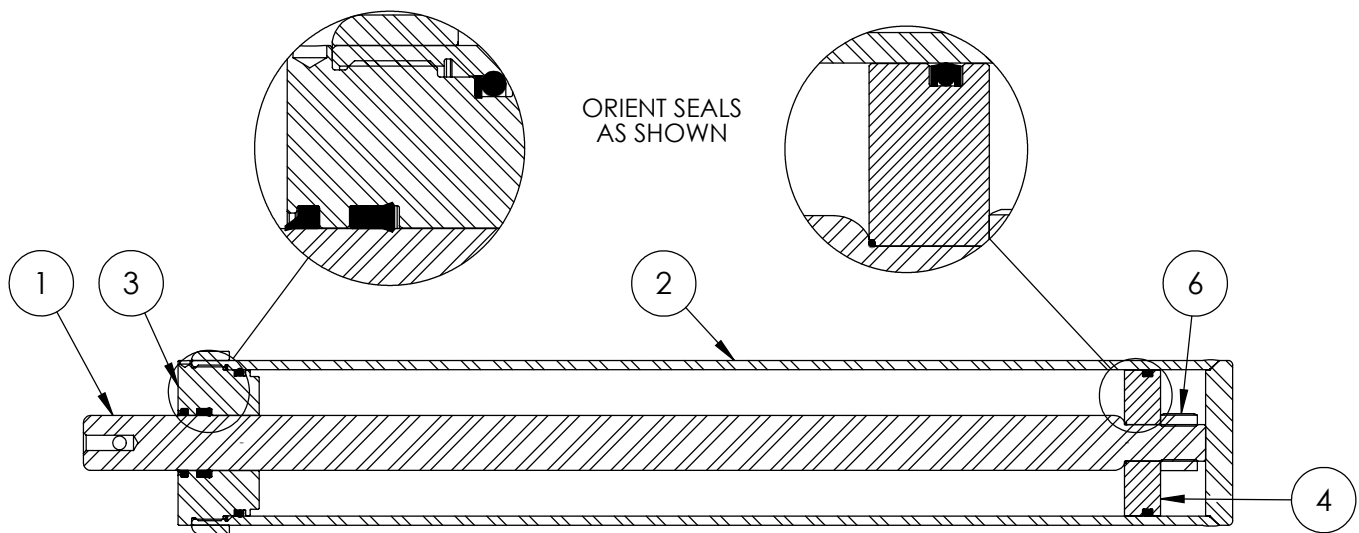

4" x 24" STROKE CYLINDER PARTS

ITEM	PART NO.	Description	QTY.
1	2011C1012	Rod, 1-1/2 x 1	1
2	2011C1014	Barrel, 4"	1
	2054C1015	*Barrel, 4" with Handle Base*	*
3	G400-150SA	4" Bore x 1-1/2" Rod Gland	1
4	P100-400SA	4" Bore Piston	1
5	SLK-4015	Seal Kit, 4 x 1-1/2	1
6	Z72292G8	Hex Lock Nut 1NF Grade 8	1

REQUIRED FOR HORIZONTAL / VERTICAL MODELS WITH HANDLE

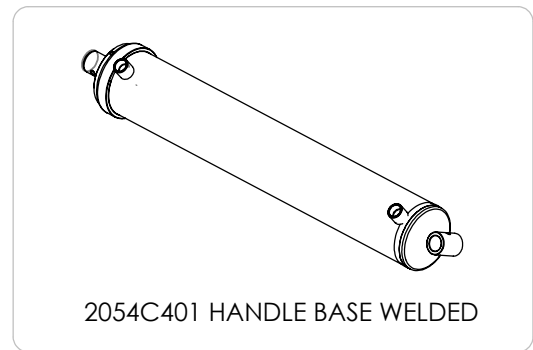

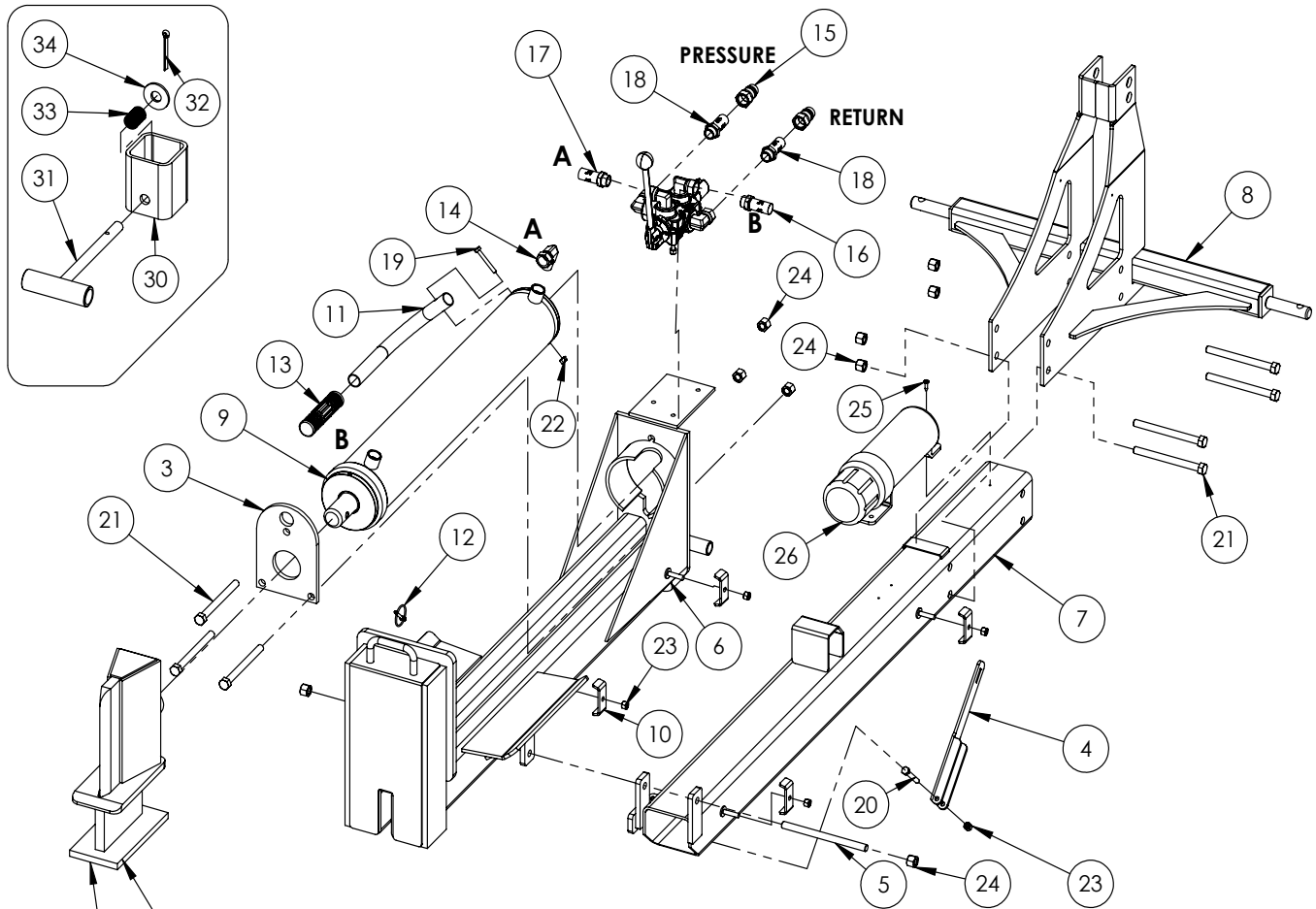

WX370 PARTS BREAKDOWN

ITEM	PART NO.	DESCRIPTION	QTY
1	2011A103	Assembly, Valve with Fittings	1
2	2014A401	Assembly, Wide Sliding Wedge	1
3	2014S421	Plate, Cylinder Retaining (Bolt)	1
4	2016L002	Locking Latch	1
5	2016M602	Pin, Pivot Threaded	1
6	2016W601	Weldment, Hor / Ver Base	1
7	2016W605	Main Base, WX370	1
8	2016W606	Weldment, 3pt Clamp-on	1
9	2054C401	Cylinder, 4 x 24 x 1-1/2 with Handle	1
10	2054L412	Clamp, Two Hose	4
11	2054S414	Handle, Lift	1
12	Z12110	Latch Pin 3/16	1
13	Z19321	Grip, 1" x 5"	1
14	Z51331	Elbow 90 MP x FPX 0808	1
15	Z51926	FP08 x Pioneer Coupler	2
16	Z52301	1/2 Hose MP08 x MP08 x 16"	1
17	Z52305	1/2 Hose, MP08 x MP08 x 24"	1
18	Z52324	1/2" Hose, 1/2MP x 1/2MP x 144"	2
19	Z71120	Hex Bolt 1/4NC x 2	1
20	Z71225	Hex Bolt 5/16NC x 2-1/2	1
21	Z71555	Hex Bolt 1/2NC x 5-1/2	7
22	Z72111	Hex Lock Nut 1/4NC	1
23	Z72221	Hex Lock Nut 5/16NC	5
24	Z72251	Hex Lock Nut 1/2NC	9
25	Z76712	Self-tapping Screw #10	1
26	Z96503	Manual Tube 3-1/2 Short	1
ITEM	PART NO.	DESCRIPTION	QTY
30	2016S604	Housing, Latch Spring	1
31	2016W603	Handle, Spring Latch	1
32	Z12321	Cotter Pin 3/16 X 2-1/2	1
33	Z32301	Spring 19mm x 79mm Med	1
34	Z73250	Wide Flat Washer, 1/2	1
ITEM	PART NO.	DESCRIPTION	QTY
40	2014W402	Weldment, Sliding Wedge	1
41	2014S414	Plate, Sliding Wedge Capture	1
42	Z71325	Hex Bolt 3/8NC x 2-1/2	1
43	Z71576	Hex Bolt 1/2NF x 1-1/2	4
44	Z72231	Hex Lock Nut 3/8NC	1

Valve Assembly

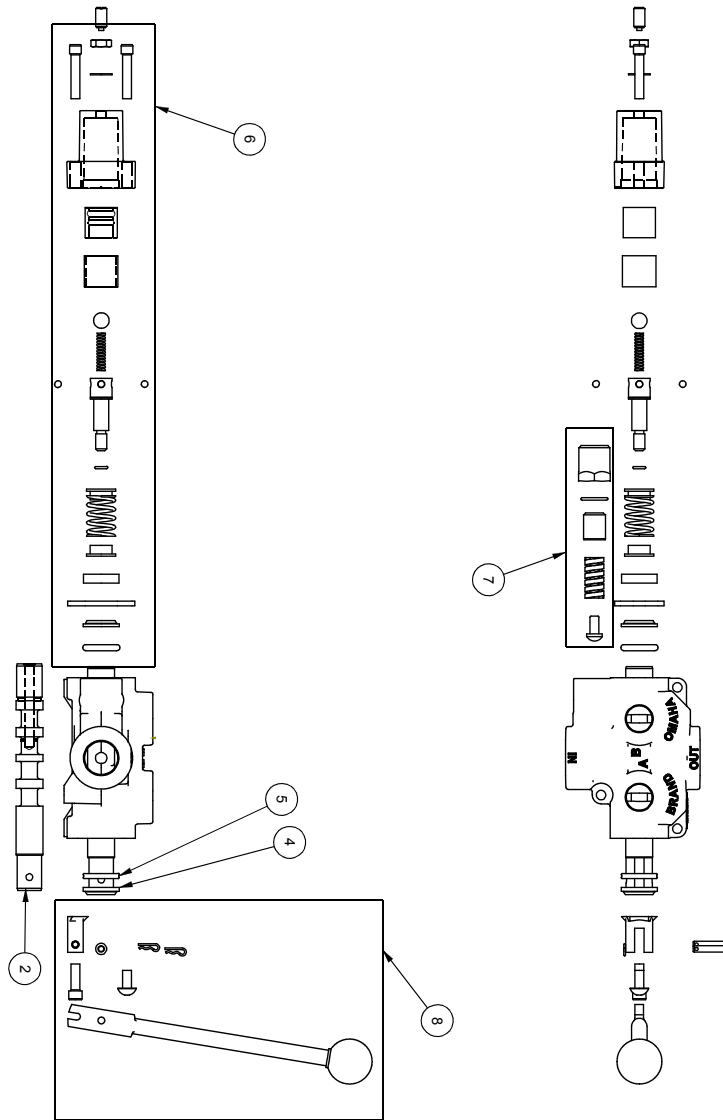

ITEM NO.	QTY.	PART NO.	DESCRIPTION
1	1	A00CASTB	AO CASTING
2	1	LS304T4J	SPOOL
3	1	P1740	NAME TAG
4	1	SF305	WIPER
5	1	SF304	QUAD RING
6	1	SUB-LS	SUB-LS
7	1	B5057	7/16 BALL
8	4	DC7604	3/16 BALL
9	1	SF306	RETAINER
10	1	SF477L	SH LS ENDCAP
11	1	XDC672	LS SLEEVE
12	1	SF483	SPACER
13	2	SF486	ALLEN SCREW
14	2	SF489	CENTER STOP
15	1	SF490	CENTERING SPRING
16	1	SF492	HOUSING
17	1	SF315	SPACER
18	1	LS305	DETENT SPRING
19	1	DC7683	O-RING 3-902
20	1	SF496	O-RING, BLUE, METRIC
21	1	LS306	LS WIPER
22	1	SF902	5/16 LOCK WASHER
23	1	SF503	PLUNGER, SPRING
24	1	SF504	5/16 HEX JAM NUT
25	1	SUB-R	RELIEF
26	1	P1603	CAP NUT
27	1	SF322	O-RING 2-016
28	1	SF364A	ADJ. SCREW
29	1	B505	SPRING
30	1	SF361A	POPPET
31	1	Z56915	HANDLE KIT
32	1	SF377	RETAINER
33	1	SF376	SEAL RETAINER
34	1	SF367A	CLEVIS
35	1	SF368	HANDLE
36	2	SF369	PIN
37	2	P1767	PIN CLIP
38	1	HP5	MACH. SCREW
39	1	SF311	KNOB
40	1	SF308	CAP SCREW
41	1	SF303T4J	SPOOL
42	1	P1694	WARNING TAG

ITEM NO.	QTY.	PART NO.	DESCRIPTION
1	1	B5057	7/16 BALL
2	4	DC7604	3/16 BALL
3	1	SF306	RETAINER
4	1	SF477L	SH LS ENDCAP
5	1	SF480	SD SLEEVE
6	1	SF483	SPACER
7	2	SF486	ALLEN SCREW
8	2	SF489	CENTER STOP
9	1	SF490	CENTERING SPRING
10	1	SF492	HOUSING
11	1	SF315	SPACER
12	1	LS305	DETENT SPRING
13	1	DC7583	O-RING 3-902
14	1	SF496	METRIC O-RING
15	1	LS306	LS WIPER
16	1	SF502	5/16 LOCK WASHER
17	1	SF503	SPRING PLUNGER
18	1	SF504	5/16 HEX JAM NUT

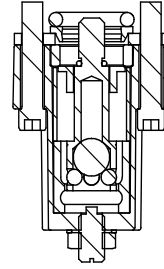
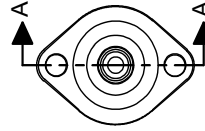
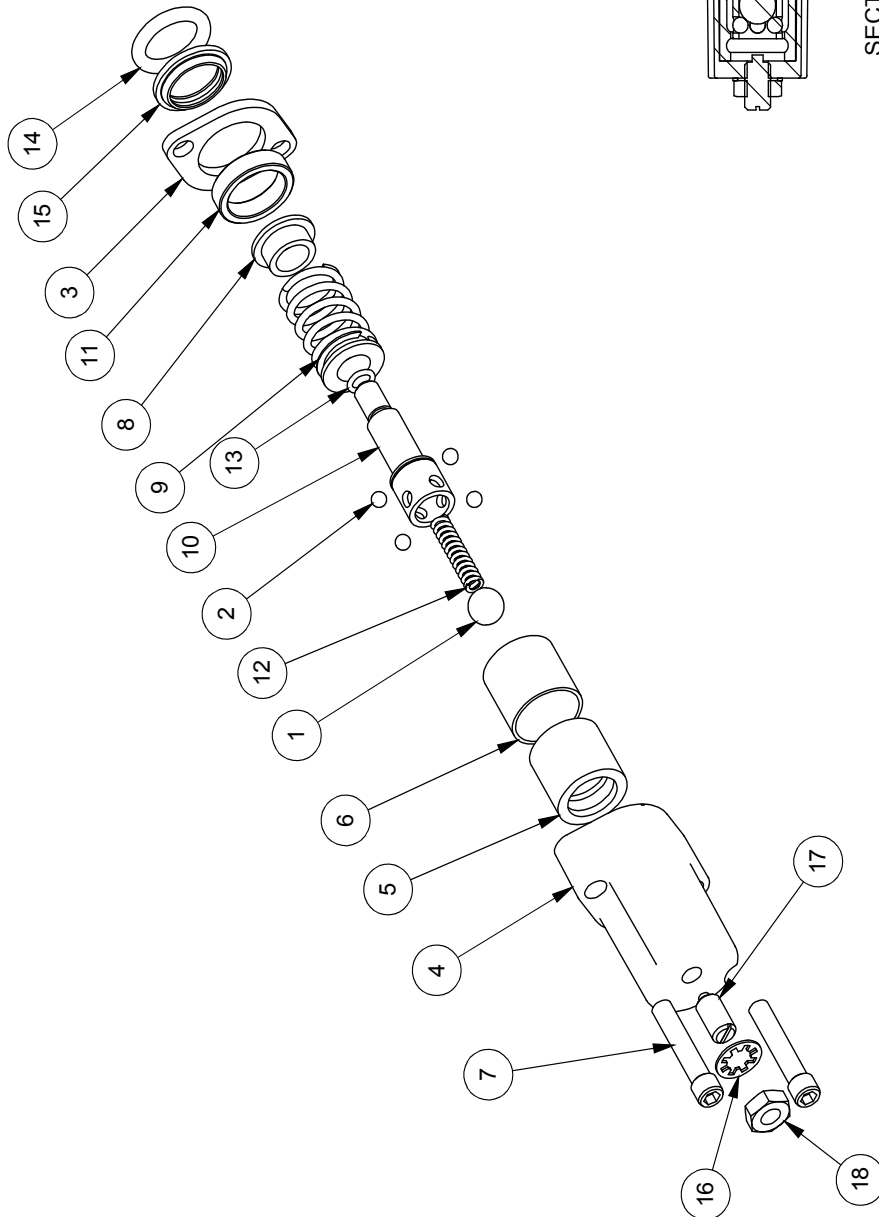

SECTION A-A

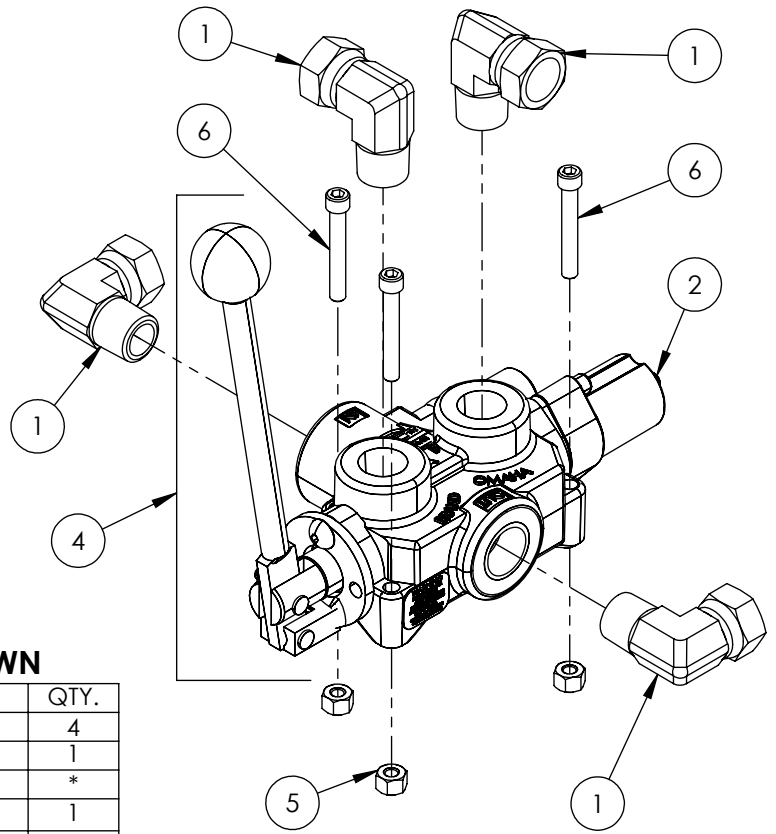

VALVE AND FITTINGS PARTS BREAKDOWN

ITEM	PART NO.	Description	QTY.
1	Z51331	Elbow 90 MP x FPX 0808	4
2	Z56209	Valve, Single Function Detent	1
3	*Z56210*	Valve, Closed Center	*
4	Z56915	Complete Handle Kit for Z56209	1
5	Z72111	Hex Lock Nut 1/4NC	3
6	Z75114	SHCS, 1/4NC x 1-3/4	3

CLOSED CENTER VALVE REQUIRED FOR "C" MODELS.

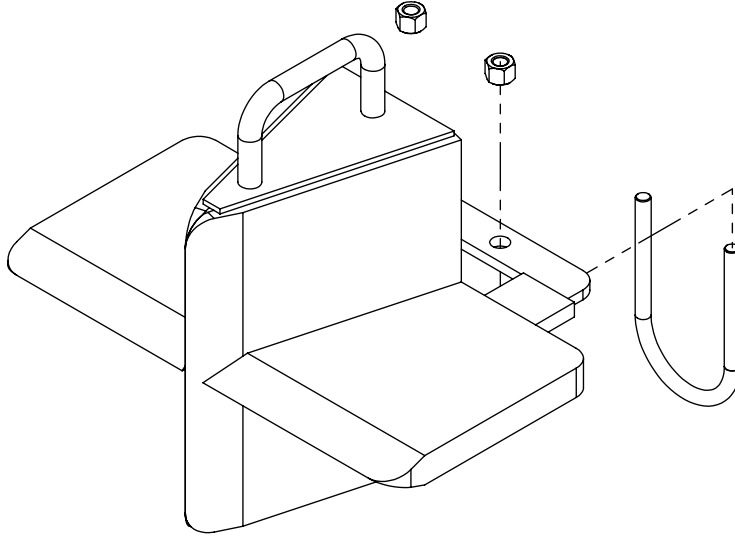

W4120 4-Way Wedge (Optional)

ITEM	PART NO.	DESCRIPTION	QTY
1	2082W201	Weldment, Main W4120	1
2	2082S201	Safety U-bolt	1
3	Z72231	Hex Lock Nut 3/8NC	2

WX370 DECAL BREAKDOWN

ITEM	PART NO.	DESCRIPTION	QTY
1	Z94039	CAUTION - Read Manual	1
2	Z94040	WARNING - Moving Wedge	2
3	Z94067	Clear Guide	2
4	Z94056	Wallenstein	2
5	Z94019	Made in Canada	4
6	Z94066	Apply Oil or Grease	1

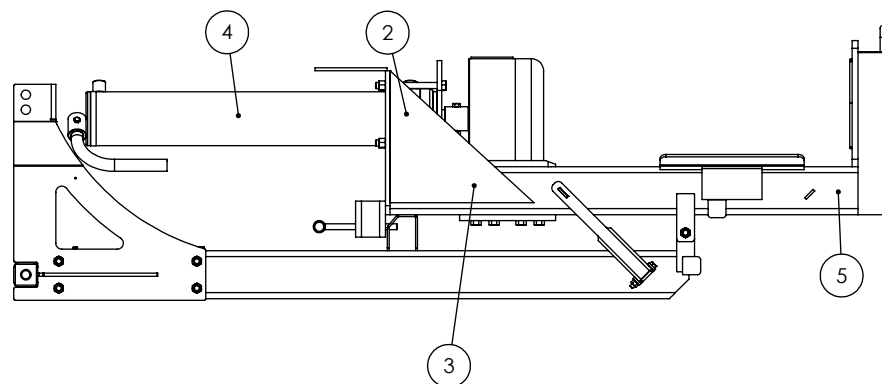
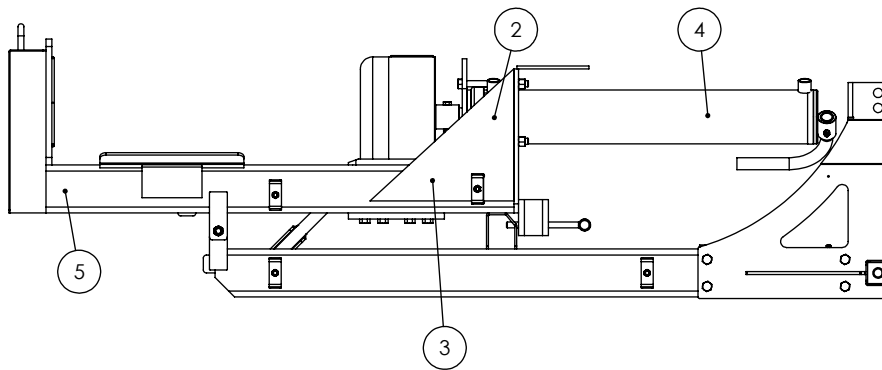
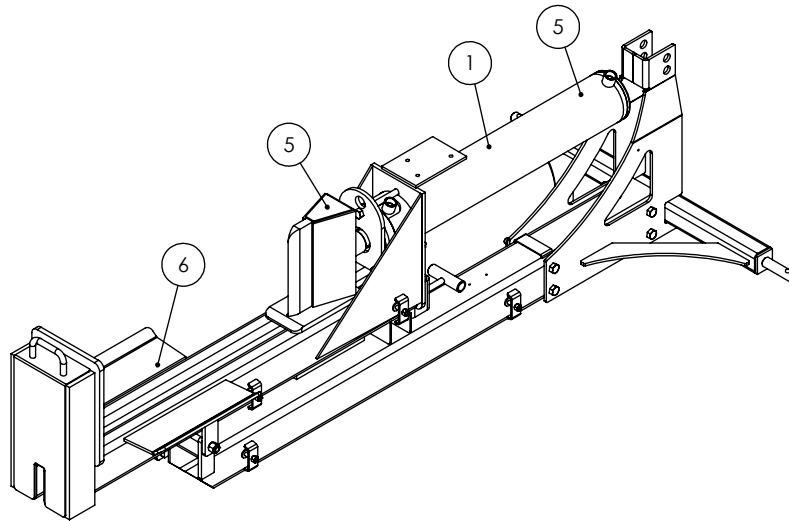

3PH Splitter Decals

Z94056



Z94067



Z94019



Z94066

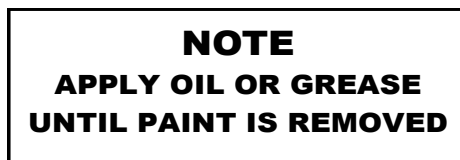

Z94039

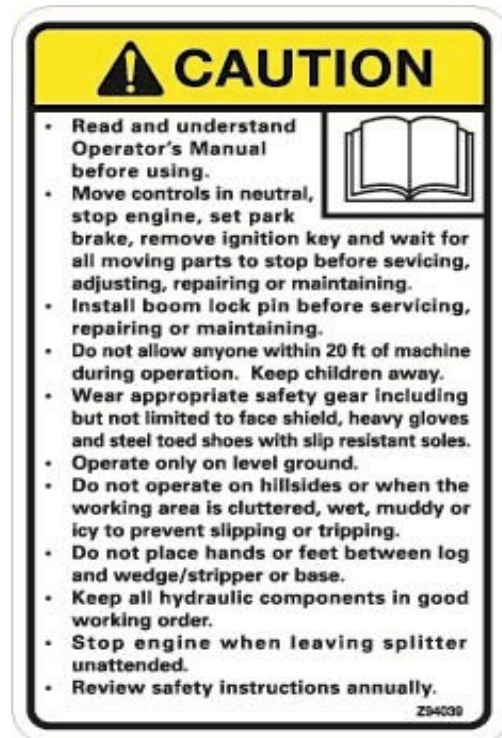

Z94040





WALLENSTEIN Products Manufactured by:

EMB MFG Inc.

4144 Boomer Line
St. Clements, Ontario
Canada N0B 2M0
Phone: 1-877-695-9283
Fax: 519-699-4146
www.embmfg.com